

## ***Standard program worldwide***

*insulbar® insulating bars for windows, doors and façades*

***Edition 2-2024***



## Table of contents

<i>Introduction to Ensinger and insulbar</i>	4-5
<i>With a standard to a system: standard profile and system group</i>	6-7
<i>System groups: typical applications</i>	8-9
<i>Always the right profile: overview of range</i>	10-11
<i>Further finishing</i>	12-13
<i>Enginger - your expert partner: range of services</i>	14
<i>The aluminum cavity makes all the difference: proposal for the aluminum cavity</i>	15
<i>Classic profiles for windows, doors and façades</i>	16-31
<i>Special profiles for doors</i>	32-33
<i>Special profiles for hidden sash</i>	34-35
<i>Special profiles - bolt operating profile</i>	36-37
<i>Special profiles for sliding systems</i>	38-39
<i>Special profiles for façades</i>	40-41
<i>Article overview</i>	42-51
<i>Additional information</i>	51

# *The thermal break professionals. Innovative and future-oriented – but steeped in tradition!*

*Plastic insulating profiles are key components for the thermal break of modern window, door and façade systems made of metal. Ensinger profiles are the first choice for quality-conscious system manufacturers and processing companies.*

***Under the brand name insulbar, Ensinger develops and produces technically superior thermal insulating bars, and for over 40 years has been one of the leading manufacturers worldwide.***

### ***Profile professionals and inventors***

It was over four decades ago that company founder and pioneer Wilfried Ensinger developed insulating profiles for metal windows, doors and façades. The driving force for this was the rising market demand for thermally improved aluminum systems, in order to thereby save on energy and costs and protect the environment. Nowadays, one associates the name Ensinger with the invention of the plastic insulating bar: durable, stable, quality made in Germany – marketed across the world under the insulbar brand name.

### ***Plastics experts and partners to industry***

insulbar represents only a part of Ensinger's extensive range of products and services. The company develops and produces – with its outstanding expertise in plastics – compounds, stock shapes, composites, finished parts and profiles made from technical plastics. These products are used nowadays in nearly all areas of industry and are impressive thanks to their cost-effectiveness and performance advantages. To process the thermoplastic engineering and high-performance plastics, Ensinger uses a number of production techniques, such as extrusion, machining, injection molding, custom casting, sintering and pressing.

**Left:**  
The Ensinger company headquarters in Nufringen near Stuttgart. Home to the company's administration, production and warehousing activities.



**Right:**  
The insulbar production facility in Cham, Bavaria.



## Efficient thermal break of window, door and façade systems with insulbar insulating bars



*Aluminum systems are weather-resistant, light and yet stable – but also have a high thermal conduction capacity. insulbar plastic insulating bars minimize this heat loss and thereby enable particularly low U values. In this way the energy consumption and hence heating and cooling costs can be lowered efficiently.*

### ***Thermal break of windows, doors and façades***

Plastic insulating bars are key components of modern window, door and façade systems made of metal. They thermally decouple aluminum frames and thereby reduce heat losses to a minimum.

### ***Insulate effectively and save energy - with insulbar insulating profiles***

insulbar insulating bars, also known as thermal insulating bars, thermal insulating profiles or insulating profiles, prevent energy losses in buildings very efficiently and enable outstanding  $U_f$  values even up to passive house standards. Reduce energy consumption, save on heating and cooling costs and protect the environment in the process – these are the effects which can be achieved with insulbar bars.

## With a standard to a system

*insulbar insulating bars from the standard program: universal, versatile, economical.*

### **Economical and rapidly available – for any task**

System manufacturers and metalworkers benefit from an extensive range of standard profiles. Using the insulating bars from the standard program, nearly all common thermally separated window, door and façade systems can be put together quickly and cost-effectively. In addition, no tool costs arise.



## All profile types from a system group

### Profile type **A**

Simple, straight or offset profile, without additional functional element.

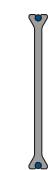

straight



offset



hollow chamber



offset with flags

### Profile type **B**

Profile for accommodating a central gasket with groove, hook or "T".



offset with groove

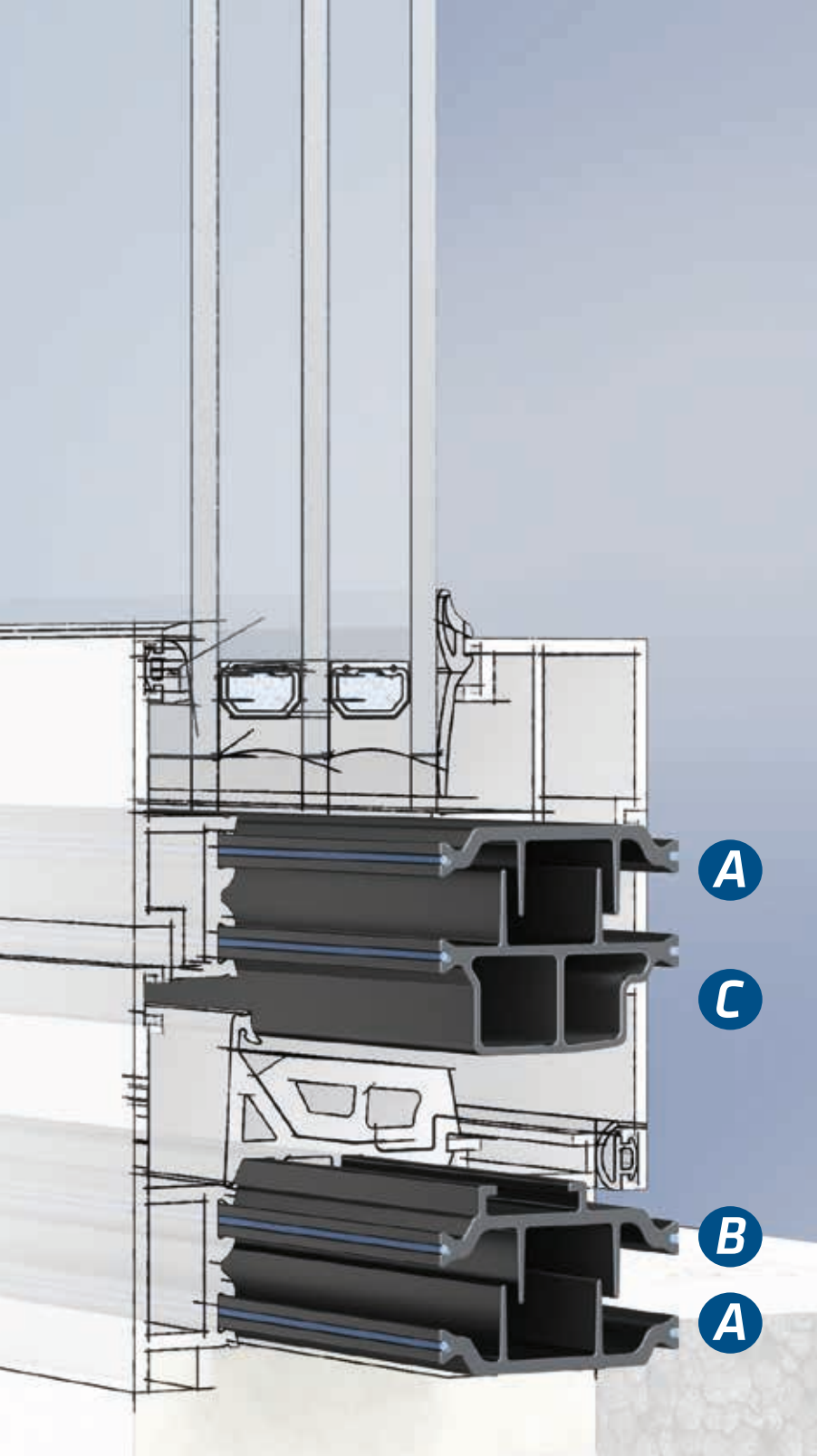

**Diversity as a matter of course**

insulbar standard profiles are available in several geometries, made from different materials and, on request, having undergone further finishing. Depending on the window type and climatic conditions, all requirements for a system are thus optimally fulfilled.

**Standard bars - the rapid system solution**

For simple and quick complete solutions for tilt and turn windows, we also offer – in the common insulation depths – several system groups as standard. These consist of three different profile types (A, B, C) in an identical size with all the requisite functional zones. The insulating bars within a group have the same base geometries and offset areas and are characterized by their standardized tolerances.

**Profile type C**

Functional element such as nose, arrow, hollow chamber.



offset with hook

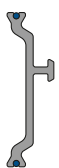

offset with "T"



offset with nose

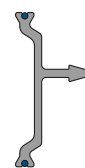

offset with arrow

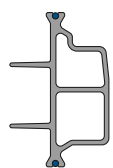

special hollow chamber

# System groups: typical applications

## Four schematic window cross sections: the right profile for every requirement

The  $U_f$  values and isothermal lines have been calculated using two-dimensional simulation software.

### 1 Standard profiles with insulation depth 14.8 mm

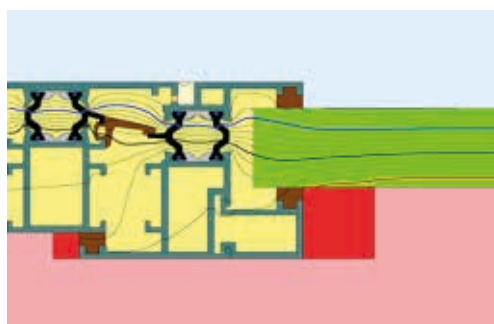

Article number: 2440, 3286, 2167

Installation depth: 45.8 mm

Visible width: 90 mm

$U_f = 3.3 \text{ W/m}^2\text{K}$

$U_w = 3.1 \text{ W/m}^2\text{K}^*$

\* Double glazing  $U_g = 2.7 \text{ W/m}^2\text{K}$

Aluminum spacer  $\Psi = 0.08 \text{ W/mK}$

### 3 Standard profiles with insulation depth 34 mm



Article number: 2807, 2805, 3172\*

Installation depth: 68 mm

Visible width: 92.5 mm

$U_f = 1.9 \text{ W/m}^2\text{K}$

$U_w = 1.1 \text{ W/m}^2\text{K}^*$

\* Triple glazing  $U_g = 0.7 \text{ W/m}^2\text{K}$

Warm edge spacer  $\Psi = 0.044 \text{ W/mK}$

\* All profiles with Low-E film on the flags

### Influence of insulation depth on the $U_f$ value

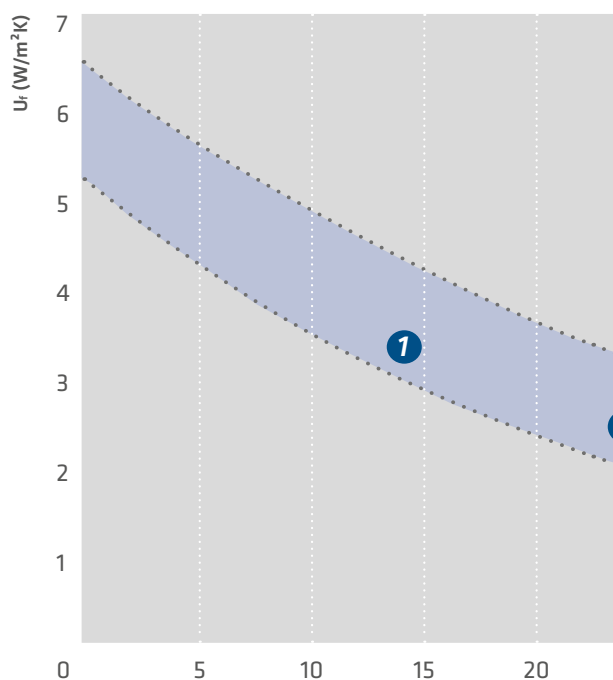

The  $U_f$  value of a thermally broken tilt and turn window is determined to a large degree by the insulating height of the insulating bar. Gaskets, flags, reflective films, insulating foams etc. also influence the thermal transmission coefficient. As visible from the graphic, the  $U_f$  value decreases with increasing insulation depth. Numbers 1 to 4 stand for the system cross sections.



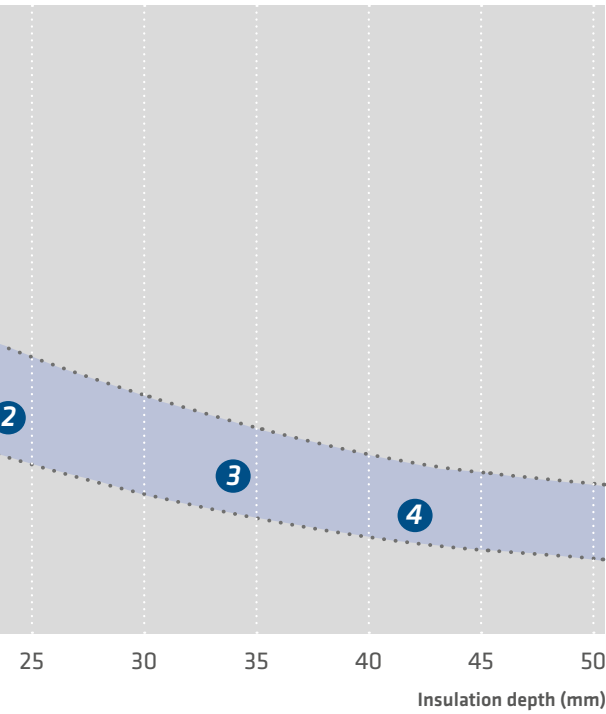

## 2 Standard profiles with insulation depth 24 mm

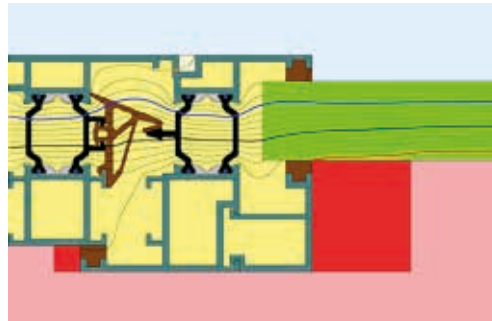

Article number: 3023, 3024, 3285

Installation depth: 58 mm

Visible width: 92.5 mm

$U_f = 2.6 \text{ W/m}^2\text{K}$

$U_w = 1.6 \text{ W/m}^2\text{K}^*$

\* Double glazing  $U_g = 1.1 \text{ W/m}^2\text{K}$

Warm edge spacer  $\Psi = 0.049 \text{ W/mK}$

## 4 Standard profiles with insulation depth 42 mm



Article number: 3272, 3273, 3274

Installation depth: 76 mm

Visible width: 96.5 mm

$U_f = 1.5 \text{ W/m}^2\text{K}$

$U_w = 1.0 \text{ W/m}^2\text{K}^*$

\* Triple glazing  $U_g = 0.7 \text{ W/m}^2\text{K}$

Warm edge spacer  $\Psi = 0.044 \text{ W/mK}$

## Always the right profile

Insulating bars for the thermal break of windows, doors and façades must above all be stable and reliable as well as having a highly insulating effect. But not all bars are the same. Different application requirements require different materials.

### insulbar RE

made of TECATHERM 66 GF RE

The recycled profile: from 100 % recycled polyamide, unmixed and with an environmental declaration.

Thanks to the special upcycling process has outstanding mechanical properties - just like the conventional insulbar insulating bars.

### insulbar REG

made of TECATHERM 66 GF

The universal profile:  
glass fibre reinforced and capable of withstanding extreme loads, for customary metal frame profiles.

made of TECATHERM 66 GF40

Highly reinforced profile with optimised strength and stiffness:  
perfect for demanding mechanical applications.

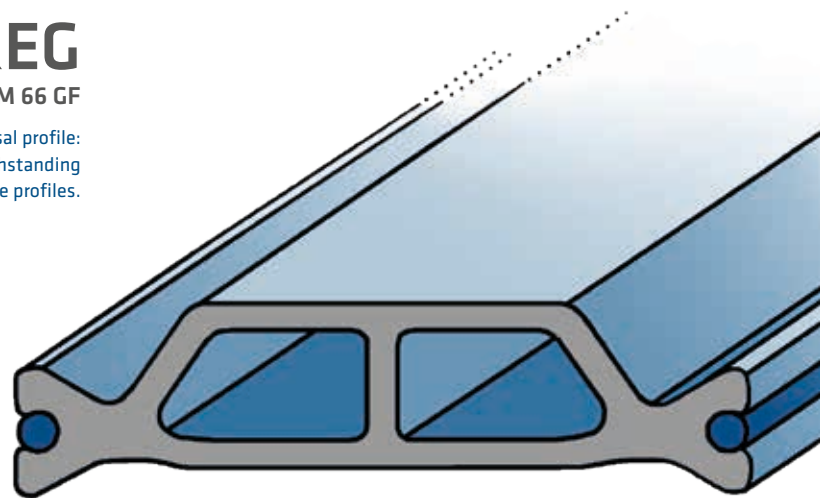

### insulbar ESP

made of TECATHERM 66 ESP

From electrostatically optimised polyamide 66 GF:  
thanks to improved powder attraction, ideal for powder coating.

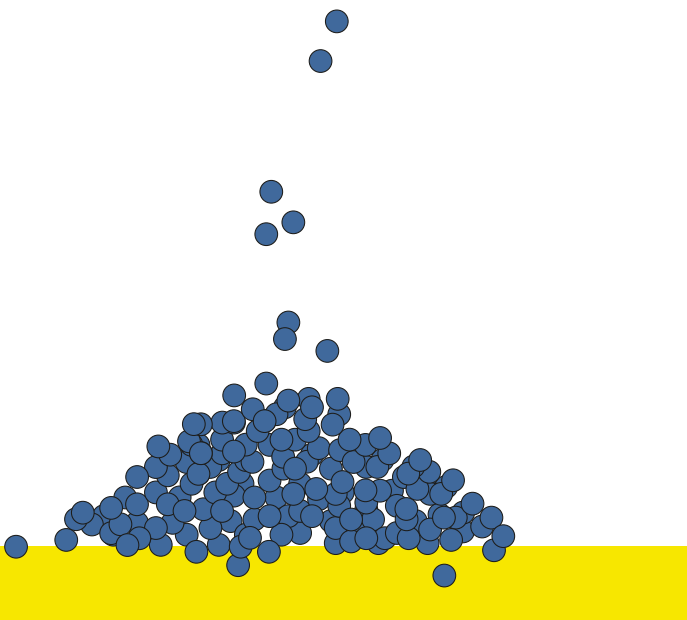

## insulbar LI

made of TECATHERM 66 GF

The insulating profile made from foamed polyamide 66 GF with a lambda value of 0.21 W/mK (in the optimum product): ideal for improving existing systems in respect of the  $U_f$  value or installation depth.

## insulbar RE-LI

made of TECATHERM 66 GF RE

The bar which combines the low thermal conduction capacity of a foamed polyamide 66 GF with the ecological advantages of recycled material: ideal for green construction.

### *insulbar materials:*

#### *it's all about the right mixture*

Our standard profiles are made from glass fiber reinforced polyamide 66, which is one of the most important engineering plastics. This material stands out for its optimum mechanical strength, high rigidity and thermal dimensional stability. It conducts little heat and also has a similar linear expansion to aluminum. For decades it has therefore been used for the thermal separation of window, door and façade systems made from aluminum.

Alongside our most common material TECATHERM 66 GF, we also offer other polyamide materials with a variety of properties, specific to the profile and application. Our applications team will work with you to ensure the correct material for your design is selected.

#### *Certified quality and performance*

insulbar bars meet high internationally applicable quality standards. This is proven by a large number of documents, for example the ATG test, Environmental Product Declaration (EPD) and Cradle-to-Cradle Material Health Certificates.



## Further finishing at the customer's request

We supply profiles that have already been fully processed – with individually defined properties and ready to assemble.

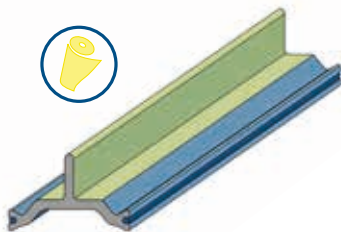

### **Film-coating with a temperature-resistant, removable film: more possibilities during powder coating**

The film protects defined areas of the profile prior to paint application and can subsequently be removed without leaving any residues.

### **Low-E film: the simple alternative to foam**

The insulating profile with a Low-E film  $12 \epsilon 3$  reflects heat radiation and thereby enables reduced  $U_f$  values without the additional use of foam.

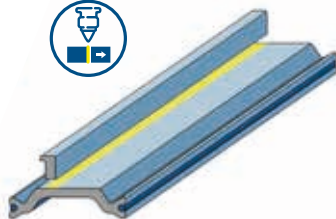
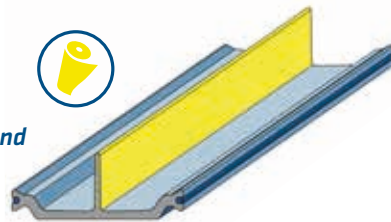

### **Milling: when it's not worth buying a new tool**

If there is so little demand for new tools that they do not represent a financially viable alternative, functional zones such as grooves can be removed from existing geometries. Flaps, too, can be shortened to a certain length or completely removed.



### **Bundling of the profiles: for easy handling in the production process**

In order to facilitate the handling of the insulating profiles during storage, order picking and processing, we offer our customers delivery of the bars in bundles with the desired numbers of units.



### **Delivery in the form of coils: easy handling, less waste**

For system manufacturers and processing companies whose logistical processes or processing methods are tailored to coils, we also supply the profiles in roll form if requested – if the geometry permits this.

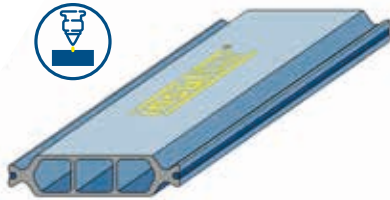

### **Marking: for optimized quality assurance**

*With inkjet or laser technology, or through embossing, customer-specific product markings can be applied to the profiles. This ensures reliable traceability of all the associated data.*

### **Sharpening of the profiles: improved drawing-in**

*“Sharpening” of the profile ends to a point facilitates the automatic insertion of the bars into the receiving cavities of the aluminum shells.*

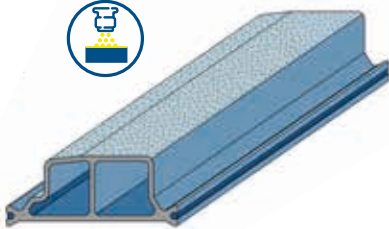
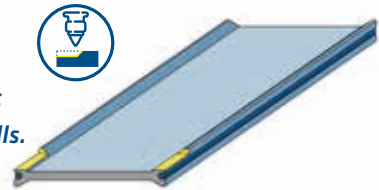

### **Dust blasting: optimum painted results**

*Dust blasting roughens the surface of the insulating bar. This increases the surface energy, improves the paint adhesion and thereby the painted result.*

### **Recesses in accordance with the tolerances in DIN ISO 2768-1 m: precise, rapid, cost-effective**

*Before the bars leave the factory we punch any desired drainage, attachment or pressure equalization openings. Application-specific boreholes or milling operations are also possible. This eliminates the need for subsequent punching by processing companies*

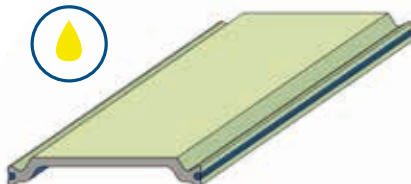
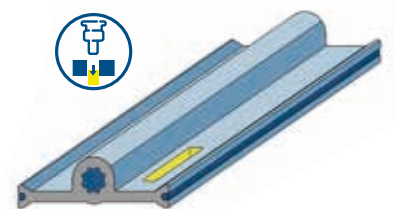

### **Conditioning: moisture content as required**

*The polyamide profiles can be conditioned in a water bath after manufacture. By this means, the moisture content of the insulating bars can be adjusted in order, for example, to facilitate subsequent machining. The moisture content is dependent on the geometry, water temperature and conditioning period.*



### Contact

Do you have questions about our insulating profiles, require detailed technical data or additional information regarding application engineering and possible uses? Or would you like to place a direct order and require a quotation? Talk to us!

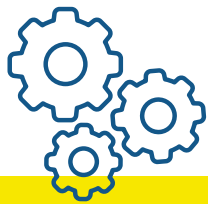

### Development and application engineering

Application engineering-related advice, from the choice of material and geometry through handling and processing to the application of insulbar insulating profiles is one of our core competencies.

We are at your side to give advice and will be pleased to help you further in every instance.

## RPT

### RPT Rapid Prototyping

Using rapid prototyping we develop and produce profile samples of your individual insulating bars, precisely in line with your specifications and wishes. We supply series-identical bars extruded from prototype tools reliably, on schedule and on fair terms.



### Production and Logistics

Our efficient, highly flexible production at several locations ensures short delivery times and enables virtually unlimited delivery quantities. Our logistics processes ensure that your goods are delivered fast, reliably and on time.



### Quality Management

Whether a standard or special solution – all insulbar bars fulfil stringent quality requirements which also comply with country-specific stipulations. Quality-relevant parameters are constantly monitored, continually checked, registered and the associated data archived for reasons of traceability.

# The cavity makes all the difference

The aluminum cavity is instrumental in determining the efficiency of the overall assembly.

The cavity of the aluminum profile forms the connection to the insulbar thermal insulating bar. Its correct configuration ensures a high shear strength, lateral stiffness and shear stiffness of the assembly.

For insulbar insulating profiles, Ensinger recommends two different aluminum cavities depending on the application. The most commonly used variant is the cavity with a short hammer. In exceptional circumstances

– for instance in the case of obstacles which make the hammer difficult to access for the roll-on wheel – Ensinger offers an alternative with a long hammer.

Both variants are compatible for most standard profiles. A full overview is provided by the table on pages 42 - 51. We will be pleased to check your cavities for compatibility with insulbar insulating profiles.



Variant 1 - short hammer



Variant 2 - long hammer

## Steps to create the perfect connection



Extruded aluminum cavity



Rolled-on hammer

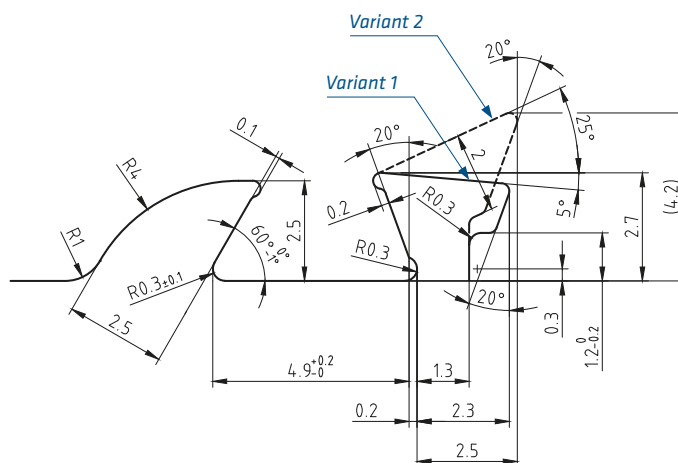

Milled cavity



Cavity with insulbar insulating profile inserted

## *Classic profiles for windows, doors and façades*

*Our classic profiles enable the thermal break of all commonly used metal systems. Depending on the window type and area of application, all requirements for insulation are thus optimally fulfilled.*

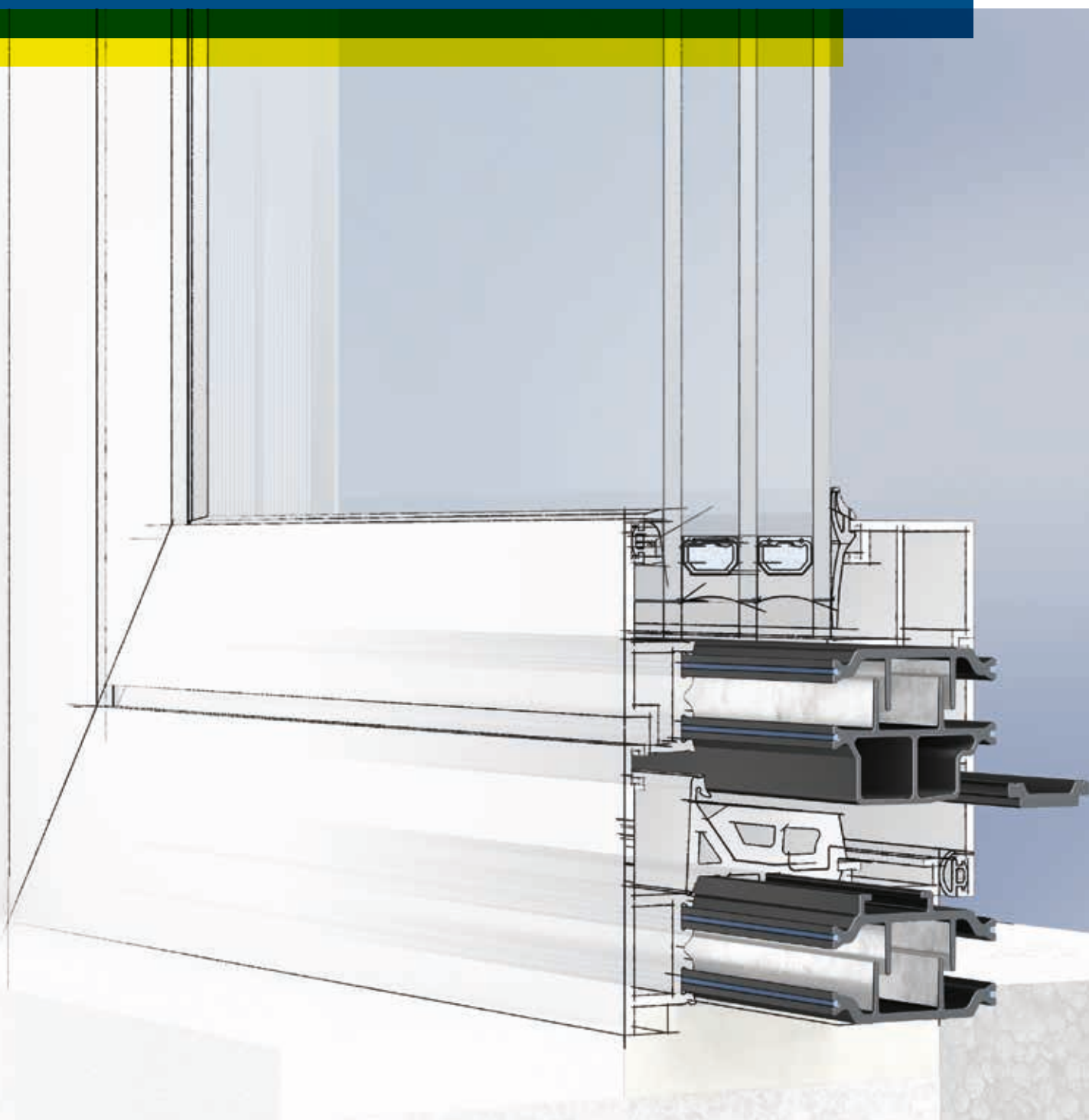



**Functionality as standard,  
diversity as a matter of course**

To meet the needs of the different window, door and façade systems, Ensinger offers insulating bars in all common profile shapes and/or geometries and for all common insulation depths (size of 10 to 54 mm). The insulating profiles are – appropriate to the particular requirements – equipped with special functional elements and can be supplied in different wall thicknesses and base geometries. Thus when designing the insulation zone the design engineer has a large number of options available to them for optimizing thermal insulation and achieving the desired  $U_f$  value.

You can find special profiles for particular applications from page 32 onwards.

**insulbar with Low-E film -  
an effective upgrade**

You can achieve a simple but effective system upgrade by using our highly reflective Low-E film 12 ε 3, which can be additionally applied to flags. This enables outstanding  $U_f$  values without the use of foams. insulbar with Low-E film is suitable for coating and anodising in the assembly.

**Coex wire -  
a reliable moisture barrier**

The coex wire integrated into the base serves to perfectly seal the assembly system. Alongside a reliable moisture barrier, it also provides additional protection against shifting of the assembly. The polyamide core of the coex wire is coated with a hot-melt glue. This melts under the impact of temperature during coating and is activated by this.

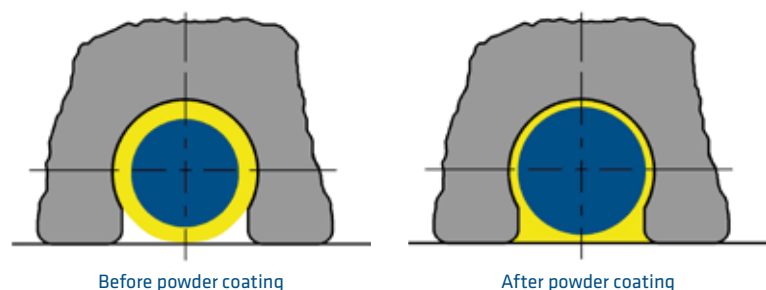

**Specific, accompanying documents**

→ Brochures: insulbar with Low-E film

→ Data sheets: Coex sealing wire

[insulbar.com/en-us/downloads](https://insulbar.com/en-us/downloads)

Not found anything suitable here? If you have any further questions, get in touch with us, we will be pleased to advise you.

# Classic profiles

10 mm	12 mm	13.4 mm	13.5 mm	14 mm	14.6 mm			
<b>3632</b> 	<b>3560</b> 	<b>2192</b> 	<b>2014</b> 	<b>2156</b> 	<b>1044</b> 	<b>2952</b> 	<b>2028 2028</b> 	<b>1953</b> 
<b>2530</b> 	<b>4698</b> 	<b>2310</b> 		<b>4386</b> 	<b>1910</b> 	<b>2045</b> 	<b>3378</b> 	
		<b>1142</b> 		<b>3557</b> 	<b>2046</b> 	<b>1674</b> 		
		<b>2164 2164</b> 		<b>2104</b> 	<b>0818</b> 	<b>1884</b> 		
		<b>2531 2531</b> 		<b>3725</b> 	<b>1173</b> 	<b>4060</b> 		
					<b>2877</b> 	<b>4059 4059</b> 		











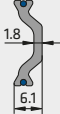
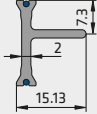
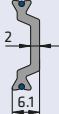

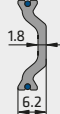



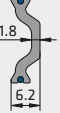
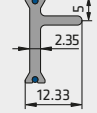
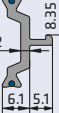

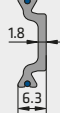
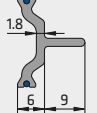
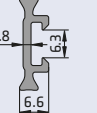

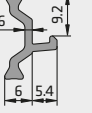

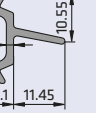
14.8 mm			15 mm	16 mm				
<b>2440</b> 	<b>2102</b> 	<b>1946</b> 	<b>1754</b> 	<b>2423</b> 	<b>1928</b> 	<b>1864</b> 	<b>1866</b> 	<b>4061</b> 
<b>2237</b> 	<b>3138</b> 	<b>2134</b> 	<b>2196 2196</b> 	<b>4102</b> 	<b>1945</b> 	<b>2634</b> 	<b>2635</b> 	
<b>3286</b> 	<b>2186 2186</b> 	<b>3368</b> 	<b>3985</b> 		<b>1947</b> 	<b>2103</b> 	<b>2335</b> 	
<b>3745</b> 	<b>0508</b> 	<b>0785</b> 			<b>1927</b> 	<b>2334</b> 	<b>2189</b> 	
<b>2167</b> 	<b>3633</b> 	<b>1135</b> 			<b>1989</b> 	<b>3714</b> 	<b>2375</b> 	
	<b>3388</b> 	<b>1090</b> 				<b>1532</b> 	<b>2376</b> 	

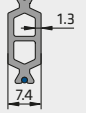
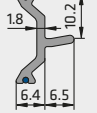
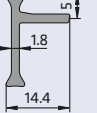
# Classic profiles

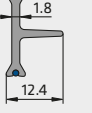
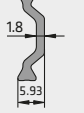
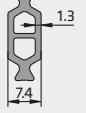
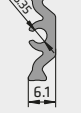
16.5 mm	16.6 mm	17 mm		18 mm				
<b>2195</b> 	<b>2147</b> 	<b>2250</b> 	<b>1918</b> 	<b>3375</b> 	<b>1987 1987</b> 	<b>2111</b> 	<b>2951</b> 	<b>2594</b> 
		<b>2262</b> 	<b>1919</b> 	<b>3374</b> 	<b>2154</b> 	<b>3715</b> 	<b>2899</b> 	<b>4683</b> 
		<b>2263</b> 	<b>3909</b> 	<b>3373</b> 	<b>1988</b> 	<b>2797</b> 	<b>3621</b> 	
					<b>2098</b> 	<b>2379</b> 	<b>2063</b> 	
						<b>2593</b> 	<b>3122</b> 	
						<b>2444</b> 	<b>4777</b> 	

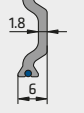
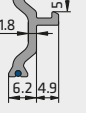

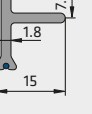
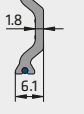
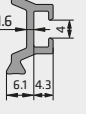
18.6 mm			20 mm				21 mm	
1926 	2520 	1418 	3062 	2521 	1673 	3255 	2907 	1136 
1991 	2126 	0346 	3199 	3591 	2742 	2016 	2909 	3804 3804 
3369 	3784 	2703 	3454 	1220 	3546 	2495 	2908 	
0838 	2305 			2605 	4199 	2365 		
1174 	3370 			2078 2078 	2031 			
3389 	2793 			2479 	4351 			

# Classic profiles

21.9 mm	22 mm	22 mm		23 mm	23.9 mm	24 mm		
<b>0748</b> 	<b>2202</b> 	<b>2049</b> 	<b>2380</b> 	<b>3341</b> 	<b>0292</b> 	<b>3425</b> 	<b>4543</b> 	<b>3023</b> 
<b>0749</b> 	<b>2204</b> 	<b>3716</b> 				<b>3387</b> 	<b>4544</b> 	<b>4063</b> 
<b>0750</b> 	<b>2203</b> 	<b>4263</b> 					<b>3893</b> 	<b>4101</b> 
		<b>2285</b> 					<b>4388</b> 	<b>3024</b> 
		<b>2062</b> 						<b>3285</b> 
		<b>3918</b> 						<b>3022</b> 



24 mm

<p><b>2206 2206</b></p>	<p><b>1922</b></p>	<p><b>1393</b></p>	<p><b>2884</b></p>	<p><b>1707</b></p>	<p><b>3390</b></p>	<p><b>3149</b></p>	<p><b>2200</b></p>	<p><b>2425</b></p>
<p><b>2279</b></p>	<p><b>1921</b></p>	<p><b>3020</b></p>	<p><b>3371</b></p>	<p><b>3380</b></p>	<p><b>3448</b></p>	<p><b>3148</b></p>	<p><b>2396</b></p>	<p><b>2902</b></p>
<p><b>2432</b></p>	<p><b>2268</b></p>	<p><b>3622</b></p>	<p><b>0839</b></p>	<p><b>3257</b></p>	<p><b>2794</b></p>	<p><b>1498</b></p>	<p><b>2165</b></p>	<p><b>3372</b></p>
<p><b>2331</b></p>	<p><b>1920</b></p>	<p><b>3283</b></p>	<p><b>1175</b></p>	<p><b>2730</b></p>	<p><b>2199</b></p>	<p><b>2214</b></p>	<p><b>2426</b></p>	<p><b>1750</b></p>
<p><b>2267</b></p>	<p><b>3021</b></p>	<p><b>2633</b></p>	<p><b>2780 2780</b></p>	<p><b>1619</b></p>	<p><b>2632</b></p>	<p><b>2191</b></p>	<p><b>4283</b></p>	
<p><b>1392</b></p>	<p><b>3284</b></p>	<p><b>2424</b></p>	<p><b>3386</b></p>	<p><b>4557</b></p>	<p><b>3258</b></p>	<p><b>2729</b></p>		

# Classic profiles

24 mm	24.8 mm		25 mm	25.3 mm	26 mm		27 mm	
<b>2774</b> 	<b>4215</b> 	<b>4214</b> 	<b>2050</b> 	<b>1058</b> 	<b>4271</b> 	<b>2006</b> 	<b>1993</b> 	<b>3078</b> 
<b>2395</b> 	<b>4216</b> 		<b>2155</b> 	<b>2106</b> 	<b>4317</b> 	<b>4492</b> 	<b>3433</b> 	<b>3080</b> 
<b>2316</b> 			<b>2051</b> 	<b>2817 2817</b> 	<b>4272</b> 	<b>1186</b> 		<b>3079</b> 
<b>2366</b> 				<b>2311</b> 		<b>2535 2535</b> 		
				<b>4330</b> 		<b>4493</b> 		
						<b>4494</b> 		





27 mm	28 mm				29 mm	30 mm		31.8 mm
<p><b>2883</b></p>	<p><b>3920</b></p>	<p><b>2795</b></p>	<p><b>2007</b></p>	<p><b>2614</b></p>	<p><b>3555</b></p>	<p><b>3432</b></p>	<p><b>3606</b></p>	<p><b>3212</b></p>
	<p><b>3798</b></p>	<p><b>4200</b></p>	<p><b>2198</b></p>	<p><b>2501</b></p>	<p><b>3761</b></p>	<p><b>1729</b></p>	<p><b>3419</b></p>	<p><b>3760</b></p>
	<p><b>3842</b></p>	<p><b>3109</b></p>	<p><b>1669</b></p>	<p><b>2515</b></p>		<p><b>3790</b></p>	<p><b>2383</b></p>	
	<p><b>3843</b></p>	<p><b>3110</b></p>	<p><b>3724</b></p>	<p><b>3413</b></p>		<p><b>4262</b></p>		
			<p><b>3896</b></p>	<p><b>3145</b></p>		<p><b>2080 2080</b></p>		
			<p><b>2796</b></p>	<p><b>3244</b></p>		<p><b>2740 2740</b></p>		

# Classic profiles

31.9 mm		32 mm			34 mm			
0724 	2522 	2638 	2728 	2727 	3829 	3377 	3826 	2765 
3723 	0774 	2246 	3025 	2764 	2807 2807 	2805 	3282 	2857 
0725 	2523 	2923 	2361 		3316 	3315 	3172 3172 	2856 
0726 	1651 	2631 	2649 		3986 	3825 		2855 
0758 	0773 	3889 	2911 		3746 	3623 		
		3057 	3444 		4327 	3620 		



34 mm			35 mm			35.3 mm	36 mm	37 mm
<b>3123</b> 	<b>1885 1885</b> 	<b>3655</b> 	<b>3391</b> 	<b>3281</b> 	<b>1986 1986</b> 	<b>4320</b> 	<b>1814</b> 	<b>4365</b> 
<b>3124</b> 	<b>3935</b> 	<b>3379</b> 	<b>3351</b> 	<b>4396</b> 	<b>3280</b> 	<b>4318</b> 	<b>3813</b> 	
<b>3125</b> 	<b>3012</b> 	<b>4402</b> 	<b>3352</b> 	<b>3279</b> 	<b>3146</b> 	<b>4319</b> 	<b>1958</b> 	
<b>1861</b> 	<b>4347</b> 	<b>3392</b> 	<b>2427</b> 					
<b>3848</b> 	<b>1650</b> 	<b>3936</b> 	<b>3229</b> 					
<b>3660</b> 	<b>4275</b> 	<b>3350</b> 	<b>3010</b> 					

# Classic profiles

38 mm	39 mm			40 mm	41 mm	42 mm		44 mm
<b>4277</b> 	<b>3827</b> 	<b>3984</b> 	<b>2429</b> 	<b>3353</b> 	<b>2636</b> 	<b>3272</b> 	<b>2655</b> 	<b>2647</b> 
<b>3824</b> 	<b>4192</b> 	<b>4786</b> 	<b>3398</b> 	<b>3354</b> 		<b>3273</b> 	<b>4202</b> 	<b>2275</b> 
<b>4075</b> 	<b>3399</b> 	<b>3400</b> 	<b>3640</b> 	<b>3812</b> 		<b>4022</b> 	<b>2656</b> 	<b>4348</b> 
<b>4276</b> 	<b>3864</b> 	<b>3636</b> 	<b>3639</b> 	<b>3307</b> 		<b>3274</b> 		<b>4349</b> 
	<b>4701</b> 	<b>3638</b> 						
	<b>3637</b> 	<b>3828</b> 						

0000 Article number 0000 Article production outside EU

System groups

New

\*Special foot width. Individual aluminium cavity design available on request.



45 mm	46 mm	49 mm	50 mm	52 mm	54 mm	77 mm
<p><b>4680</b></p>	<p><b>3641</b></p>	<p><b>2969</b></p>	<p><b>3311</b></p>	<p><b>4461</b></p>	<p><b>3339</b></p>	<p><b>4813</b> </p>
<p><b>4682</b></p>		<p><b>3068</b></p>	<p><b>4062</b></p>		<p><b>3338</b></p>	
			<p><b>3310</b></p>		<p><b>3277</b></p>	
					<p><b>3278</b></p>	

# Classic profiles

20 mm	24 mm	26 mm	28 mm	29 mm	30 mm	32 mm	33 mm	34 mm
<b>4245</b> 	<b>4543</b> 	<b>4616</b> 	<b>4618</b> 	<b>4178</b> 	<b>4370</b> 	<b>4467</b> 	<b>4474</b> 	<b>3829</b> 
	<b>4544</b> 	<b>4542</b> 	<b>4804</b> 		<b>4367</b> 	<b>4468</b> 		<b>3377</b> 
	<b>3893</b> 	<b>4617</b> 	<b>4296</b> 		<b>4368</b> 	<b>4469</b> 		<b>2807</b> 
	<b>4388</b> 		<b>4298</b> 		<b>4371</b> 	<b>4620</b> 		<b>2805</b> 
			<b>4056</b> 		<b>4619</b> 	<b>3957</b> 		<b>3172</b> 
								<b>3282</b> 



34 mm	37 mm	39 mm		40 mm	42 mm	43 mm	44 mm	45 mm
<p><b>4621</b></p>	<p><b>4325</b></p>	<p><b>3827</b></p>	<p><b>4623</b></p>	<p><b>3353</b> </p>	<p><b>4503</b> </p>	<p><b>4458</b> </p>	<p><b>4622</b></p>	<p><b>4807</b> </p>
<p><b>1861</b></p>		<p><b>3399</b></p>	<p><b>3398</b></p>	<p><b>4518</b></p>				
<p><b>4720</b></p>		<p><b>4701</b></p>						
		<p><b>3984</b></p>						
		<p><b>4786</b> </p>						
		<p><b>3400</b></p>						
								<p><b>48 mm</b></p> <p><b>4666</b> </p>

## Special profiles for doors

*The ideal solution for doors with thermal breaks: shear-free profiles from insulbar minimise the impact of the bi-temperature effect. In this way the door stays in perfect shape even in the case of extreme differences between the external and internal temperature.*



### **How the door stays in shape**

The shear-free insulating bar consists of two intermeshing parts. With temperature-related, differing linear expansion of the inner and outer shells, the two parts shift against one another. A moveable, corrective insulating zone is generated which minimizes the bi-temperature effect and reduces deformation of the door effectively. Thanks to this solution, top climate categories can be achieved for aluminum doors.

### **Easy to process**

A rivet at the end of the profile rod prevents slippage of the two parts of the bar during processing. By this means, the anti-bi-metal profile can be easily drawn into the aluminum cavity like a conventional insulating bar, and coated in the assembly. To ensure the assembly is perfectly balanced, Ensinger recommends that insulbar shear-free be incorporated with the profiles as mirror images.

To ensure that drawing-in as mirror images is straightforward, we supply the shear-free bars appropriately aligned: half of the goods are ready-turned in the stillage. Two rivets of different colors ensure clear marking of the direction of rotation of the plastic profiles

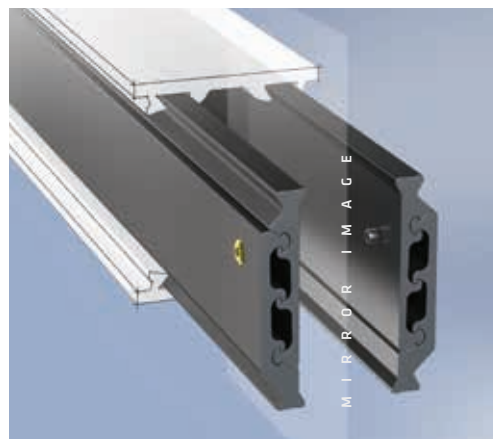



### Advantages

- Can be rolled up and laminated like a conventional insulating profile
- Ensures high transverse tensile strength Q thanks to optimized geometry
- Minimizes shear stiffness c and ensures low shear strength T
- Reduces the bi-temperature effect more significantly compared with shear-weak and shear-resistant profiles

### Specific, accompanying documents

- Brochures: Shear-free insulating profile from insulbar  
[insulbar.com/en-us/downloads](http://insulbar.com/en-us/downloads)

Not found anything suitable here? If you have any further questions, get in touch with us, we will be pleased to advise you.

## Our recommendation

### Material shear-free















- TECAHTERM 66 GF
- TECAHTERM 66 GF RE

### Further processing



You can find more detailed information on pages 10-13

## Shear-free profiles

18 mm	20 mm	22 mm	24 mm	26 mm	28 mm	30 mm	32 mm	
3989  6.15	3963 3963  6.15	3995  6.15	3998  6.15	4004  6.15	4007  6.15	3884  6.15	4010  6.15	4788 
34 mm	36 mm	42 mm	44 mm	46 mm				
4013  6.15	4362  6.15	4019  6.15	4789  6.15	4607  6.15				

Also, additional shear-free bars are available to you for trials from our RPT technology, in the insulation depths 25 and 40 mm

## Special profiles for hidden sash

*Hidden sash windows have particular appeal thanks to their elegant design with a particularly slim frame. The window sash is completely hidden and does not have any outer shell. The glazing is held directly on the insulating bar by the glazing bead.*

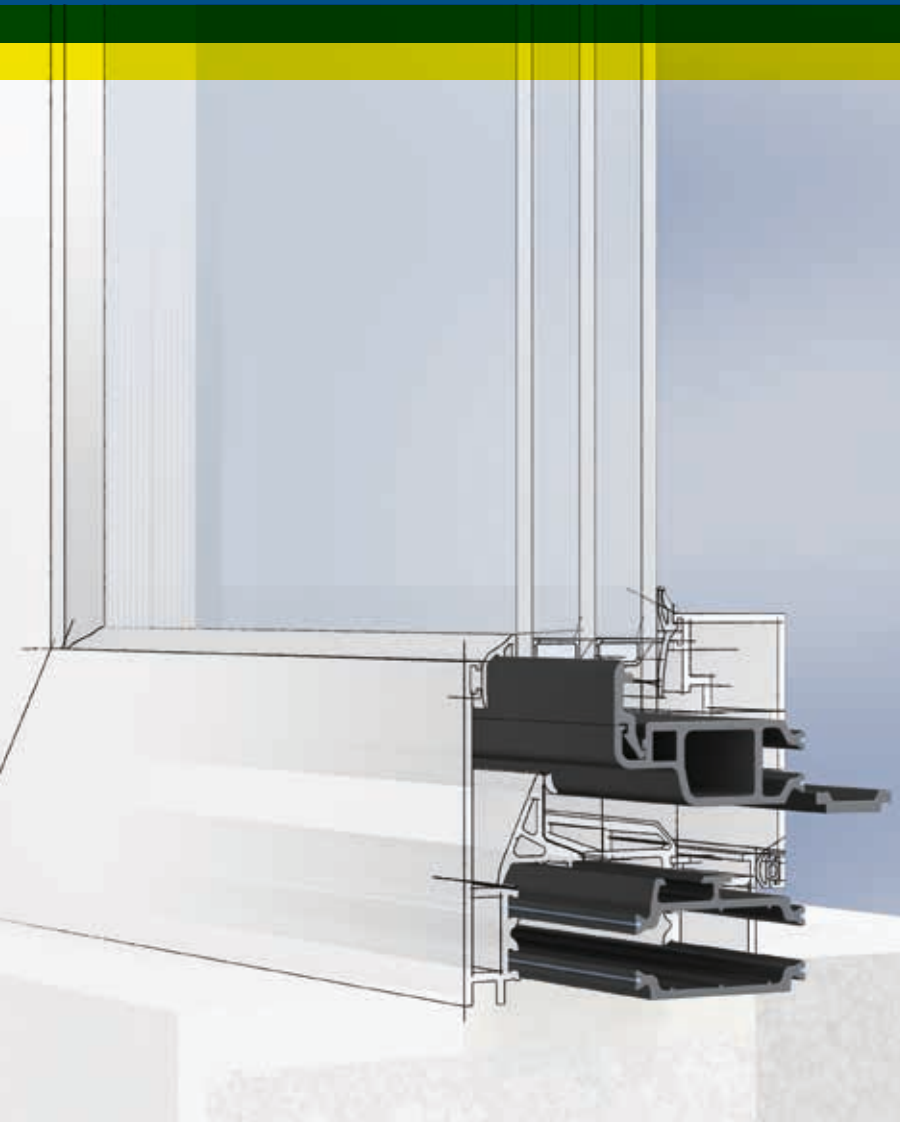

### ***insulbar profiles for hidden sash***

#### ***Enables high design and insulation standards***

Hidden sash windows combine an elegant, light appearance with slim visible widths and very good  $U_w$  values. The insulbar profiles, specially developed for these systems, either have a wide roll-in base or two bases which are connected to the inner shell of the sash. Narrow tolerances enable the profiles to be easily inserted into the aluminum cavity.

#### ***For an optimum painted result: insulbar ESP***

With assemblies that are difficult to coat, for example the hidden sash, insulbar ESP is the ideal solution.

The insulating profile made from electrostatically modified material ensures improved attraction of paint particles during powder coating of the assembly. Combined with a dust-blasted surface of the plastic bar, the particles thereby adhere significantly better to the material. The result is a perfect painted finish.

## Our recommendation

### Material profiles for

#### hidden sash

- TECATHERM 66 GF
- TECATHERM 66 GF RE
- TECATHERM 66 ESP

#### Material glazing bead

- TECATHERM 66 GF
- TECATHERM 66 GF RE
- TECATHERM 66 GF40

#### Further processing



#### Further processing



You can find more detailed information on pages 10-13

## insulbar glazing bead

### An alternative to aluminum

For further improvement of the  $U_w$  value, glazing beads made from aluminum can be replaced with bars made from glass fiber reinforced polyamide. To meet high demands regarding mechanical stability, the bead supplied can be made from the material TECATHERM 66 GF40 with a particularly high glass fiber content.

### Specific, accompanying documents

- Brochures: insulbar ESP
  - Data sheets: TECATHERM 66 ESP
- [insulbar.com/en-us/downloads](https://insulbar.com/en-us/downloads)

Not found anything suitable here? If you have any further questions, get in touch with us, we will be pleased to advise you.

## Profiles for hidden sash

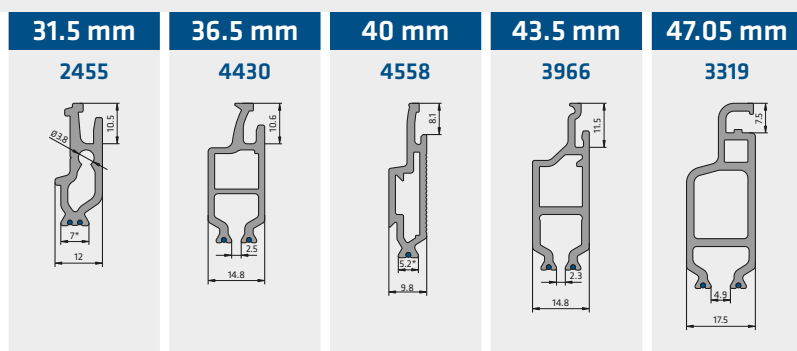

## Glazing bead

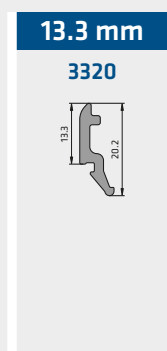

## Special profiles - bolt operating profile

*insulbar bolt operating profiles are the perfect alternative to metal push rods: the plastic profile prevents the rattling in the window commonly encountered with aluminum rods. A sophisticated packaging and spool concept ensures ease of handling and cost-effective processing.*

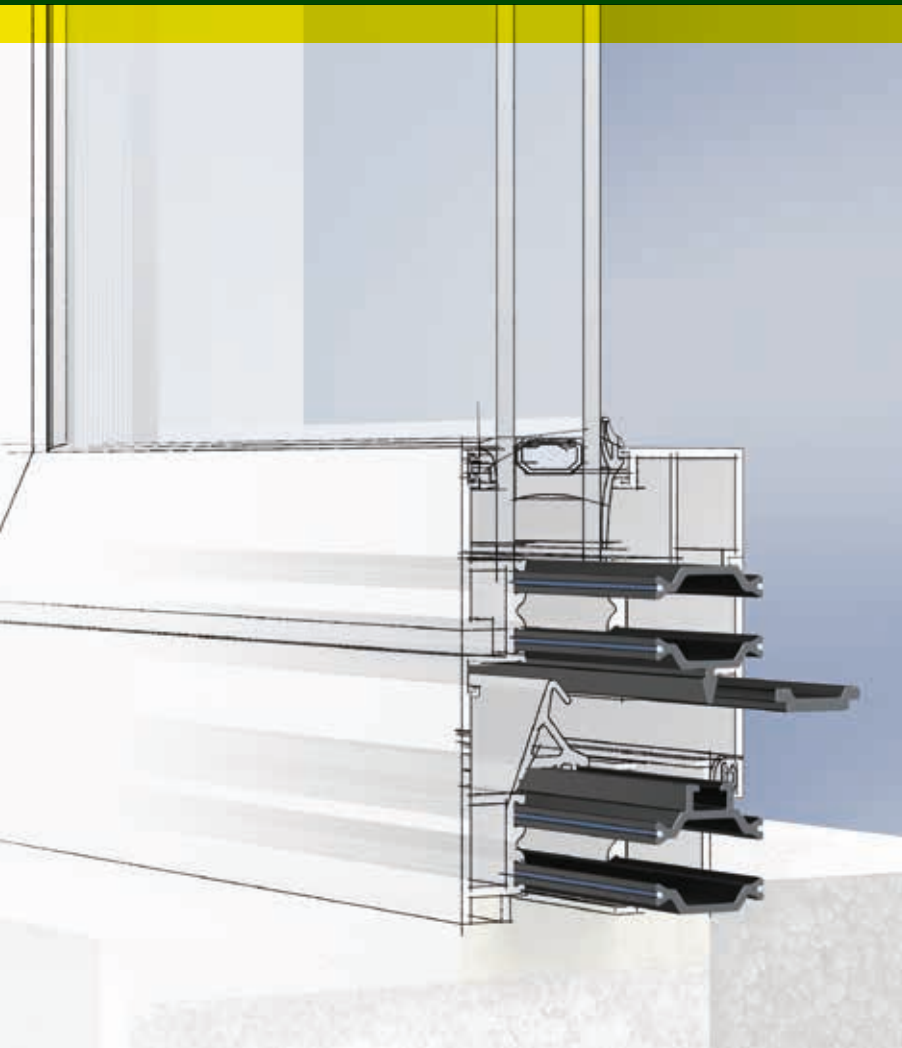

### **All nicely wound**

All bolt operating profiles are available as rolled goods, referred to as coils. You therefore have less waste from unnecessary cutting compared with cut lengths. Reusable spools from Ensinger fix the wound profile and dispense with the need for disposable spools.

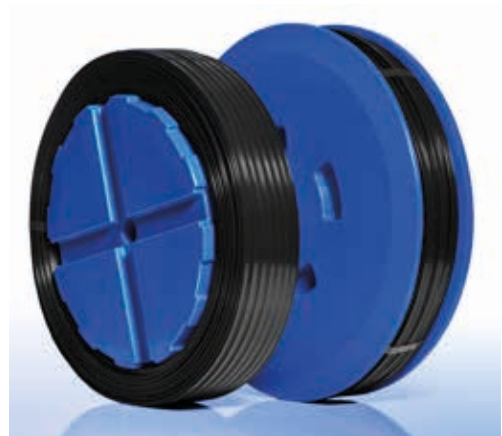

With two different types of spools (left: single spool, right: double spool) the coils fit onto all commonly available unwinding facilities.

## Our recommendation

### Material bolt operating profiles

- TECATHERM 66 GF
- TECATHERM 66 GF RE

### Further processing



You can find more detailed information on pages 10-13

### Easy handling, guaranteed quality

The coil can simply be positioned on the spool and fixed in the unwinding machine. Thanks to the optional orderly winding and stable fixing, the bolt operating profile runs into the blank in a straight line, stress-relieved and without tilting. Precise, accurately positioned punching operations are the result.

### Specific, accompanying documents

→ Brochures: [insulbar.com/en-us/downloads](https://insulbar.com/en-us/downloads)

Not found anything suitable here? If you have any further questions, get in touch with us, we will be pleased to advise you.

## Bolt operating profiles

17.7 mm	19.5 mm			19.7 mm
3778	3266	3582	3668	1840

## Special profiles for sliding systems

*Thermally broken sliding systems enable contemporary and open room concepts and create a pleasant indoor climate at all times. At the same time they must meet tough functional and thermal requirements. Special insulating profiles from Ensinger help with this.*



### **Runner profiles for maximum functionality**

Runner profiles from the material TECATHERM 66 GF have a very smooth surface with very narrow tolerances. They thereby guarantee movement that is as friction-free as possible.

With large elements, runner profiles made from TECATHERM 66 GF40 with an increased glass fiber component are suitable, as is Article 3129, where additionally a metal rail is inserted.

### **Chicane for the middle section**

Chicanes are in the visible area, therefore appearance plays an important part. Like all insulbar bars, our chicanes have a deep black, shiny surface. Lots of customized chicanes are coated in the assembly. Here, Ensinger recommends these dust-blasted from electrostatically modified TECATHERM 66 ESP. Attraction and adhesion of the powder particles is thereby improved significantly and ensure an optimum painted result.

### Special profiles for sliding systems

By way of an addition, our program for sliding systems also encompasses special profiles e.g. for incorporating the roller cage or bolt operating profile.

### Specific, accompanying documents

→ Data sheets: TECATHERM 66 ESP,  
TECATHERM 66 GF40  
[insulbar.com/en-us/downloads](http://insulbar.com/en-us/downloads)

Not found anything suitable here? If you have any further questions, get in touch with us, we will be pleased to advise you.

## Our recommendation

### Material chicanes

- TECATHERM 66 GF
- TECATHERM 66 GF RE

### Material runner rails

- TECATHERM 66 GF
- TECATHERM 66 GF RE
- TECATHERM 66 GF40

### Material supplementary profiles

- TECATHERM 66 GF
- TECATHERM 66 GF RE
- TECATHERM 66 GF40

### Further processing



You can find more detailed information on pages 10-13

## Chicanes

3298

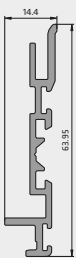

3077

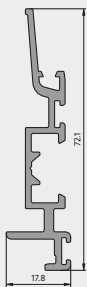

3493

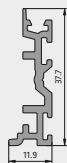

3342

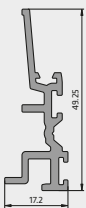

3494

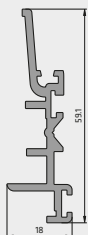

## Supplementary profiles

2834 2834

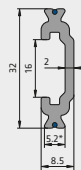

3726

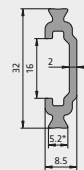

2910

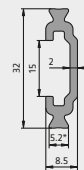

3008

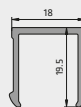

3424

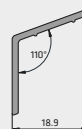

2435

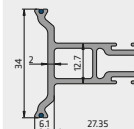

## Runner rails

2835 2835



3129



## Special profiles insulbar for façades

*Spacers and roll-in profiles made from polyamide are the perfect complement to thermally broken façade systems – above all when it comes to green construction. Because all profiles are also available made from 100 % recycled polyamide.*

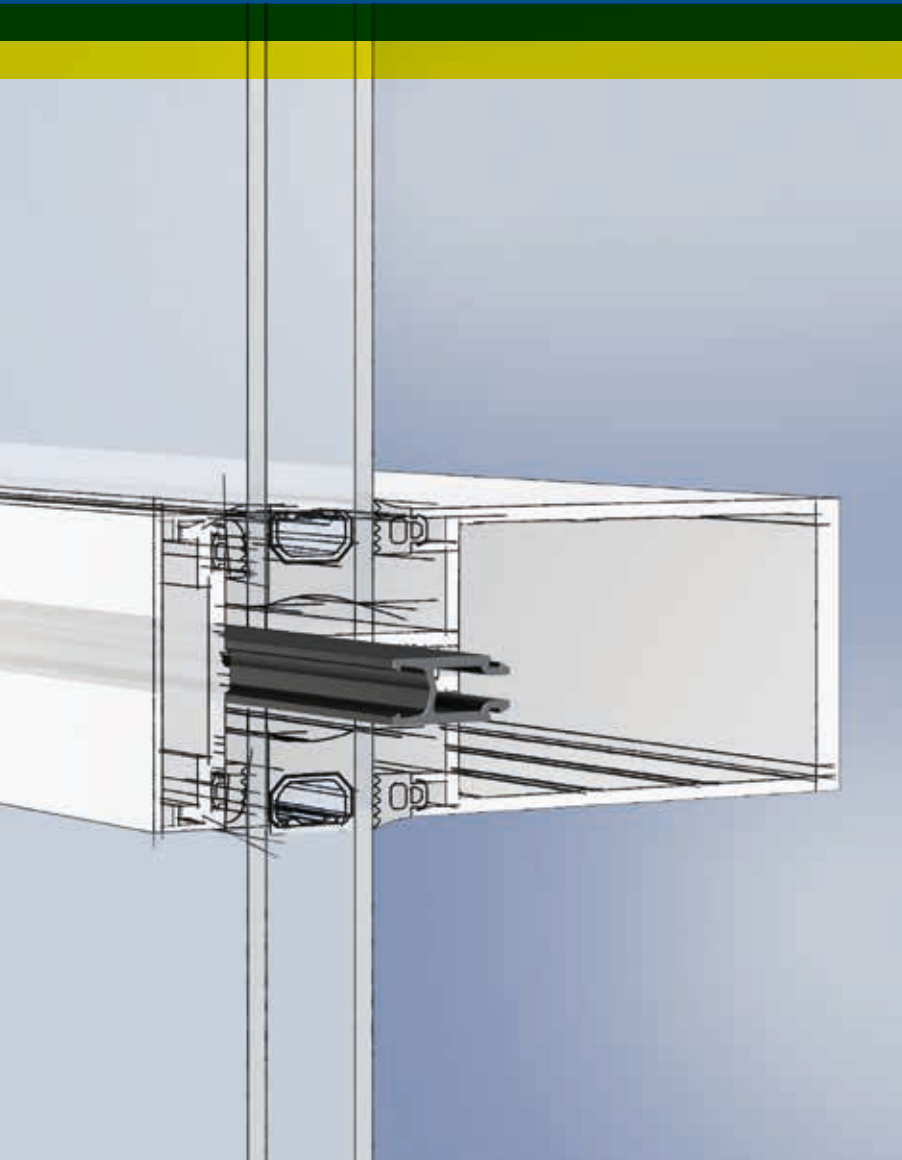

### **Spacers for curtain walls**

Owing to the improved thermal dimensional stability and the increased requirements in relation to fire safety, spacers made from glass fiber reinforced polyamide are increasingly being incorporated into the mullion and transom façade. For optimized thermal insulation, PE foams can additionally be glued to the side of these.

### **Roll-up profiles for element façades**

In order to thermally separate the aluminum shells of element façades, conventional roll-up bars made from PA 66 GF are used. They reduce heat losses and enable large areas of glass with low U values. All of our materials recommended for the façade fulfill the requirements relating to suitability for thermal separation in line with DIN EN 14024.

You can find more on insulbar classic profiles on pages 16 and 17.

Through a combination of two spacers, the insulation depth of the façade can be adapted to fit the particular filling thickness

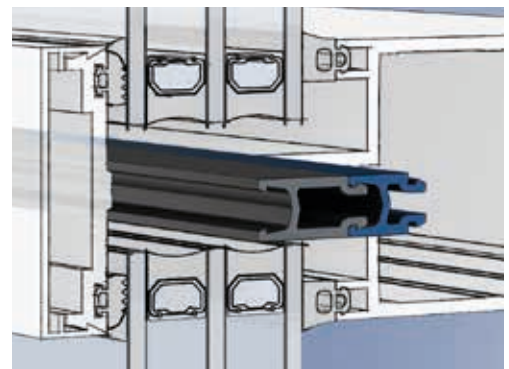



**Green construction – building certification made easy**

Particularly in project business and in construction projects with building certification, green construction in line with DGNB, LEED or BREEAM plays a key role. For this reason, like with all other insulbar bars, façade profiles from unmixed recycled polyamide with a significantly reduced CO<sub>2</sub> footprint are also available.

Customized solutions such as glass edge profiles, contact pressure rails or special spacers are available on request.

**Specific, accompanying documents**

→ Brochures: insulbar RE

[insulbar.com/en-us/downloads](http://insulbar.com/en-us/downloads)

**Our recommendation**

**Material spacers**

- TECATHERM 66 GF
- TECATHERM 66 GF RE

**Material pressure plate**

- TECATHERM 66 GF
- TECATHERM 66 GF RE
- TECATHERM 66 GF40

**Material glass edge profiles**

- TECATHERM 66 GF
- TECATHERM 66 GF RE

**Further processing**



You can find more detailed information on pages 10-13

Not found anything suitable here? If you have any further questions, get in touch with us, we will be pleased to advise you.

**Spacers**

<p><b>11.6 mm</b></p> <p><b>3693</b></p>	<p><b>21.15 mm</b></p> <p><b>3585</b></p>	<p><b>15 mm</b></p> <p><b>3297</b></p>	<p><b>17.5 mm</b></p> <p><b>3836 3836</b></p>	<p><b>20.5 mm</b></p> <p><b>4329</b></p>
<p><b>17.6 mm</b></p> <p><b>3747</b></p>	<p><b>26.25 mm</b></p> <p><b>3584</b></p>	<p><b>32 mm</b></p> <p><b>3102 3102</b></p>	<p><b>36.65 mm</b></p> <p><b>2705</b></p>	

**Glass edge profiles**

<p><b>29.7 mm</b></p> <p><b>4331</b></p>
<p><b>37.7 mm</b></p> <p><b>4332</b></p>

**Pressure plate**

<p><b>61.65 mm</b></p> <p><b>4700</b></p>
---

Article number	Insulating depth (mm)	Description of the geometry	Pieces per stillage *	Foot compatible with aluminum cavity suggestion short hammer	Foot compatible with aluminum cavity suggestion long hammer	Coils **
0292	23.9	straight	2400	■	■	☉
0346	18.6	straight with nose	2300	■		
0508	14.8	straight	4800	■	■	☉
0724	31.9	offset	1600	■		
0725	31.9	offset with groove	1500	■		
0726	31.9	offset with nose	1000	■		
0748	21.9	offset	2500	■		☉
0749	21.9	straight with groove	2400	■		
0750	21.9	offset with nose	1300	■		
0758	31.9	offset with nose	1100	■		
0773	31.9	straight with nose	1000	■	■	
0774	31.9	straight	2000	■	■	☉
0785	14.8	straight with nose	3000	■	■	
0818	14.6	straight	4500	■	■	☉
0838	18.6	straight	3000	■	■	☉
0839	24	straight	3100	■	■	☉
1044	14	straight	4800	■	■	☉
1058	25	straight	2400	■	■	☉
1090	14.8	straight with nose	3000	■	■	
1135	14.8	straight with nose	3000	■	■	
1136	21	straight	2700	■	■	☉
1142	12	straight	5200	■	■	☉
1173	14.6	straight	4800	■	■	☉
1174	18.6	straight	3000	■	■	☉
1175	24	straight	3600	■	■	☉
1186	26	straight	2200	■		☉
1220	20	straight	2900	■	■	☉
1392	24	offset with nose	1150	■		
1393	24	offset	2300	■		☉
1418	18.6	straight with nose	1700	■	■	
1498	24	straight with arrow	1300	■	■	
1532	16	offset	3200	■	■	☉
1619	24	offset	2300	■	■	☉
1650	34	offset	1700	■		
1651	31.9	offset	1500	■	■	
1669	28	offset	1900	■	■	
1673	20	offset	2600	■	■	☉
1674	14.6	straight with nose	3000	■	■	
1707	24	straight with noses	2400	■	■	☉
1729	30	straight	2500	■	■	☉
1750	24	straight with nose	1300			
1754	15	straight	4200	■	■	☉
1814	36	straight	2200	■	■	☉
1840	19.7	bolt operating profile	2500			☉
1861	34	3 hollow chambers	1300	■	■	
1864	16	straight	4000	■	■	☉
1866	16	straight with arrow	2300	■	■	
1884	14.6	straight with nose	3000	■	■	
1885	34	straight	2000	■	■	☉
1910	14.6	straight	4500	■	■	☉
1918	17	offset with groove	1800	■		
1919	17	offset with nose	1800	■		

\* approximate values, which can deviate in individual cases \*\* Dimensions may differ; LI and RE-LI not available in coils

Article number	Insulating depth (mm)	Description of the geometry	Pieces per stillage *	Foot compatible with aluminum cavity suggestion short hammer	Foot compatible with aluminum cavity suggestion long hammer	Coils **
1920	24	straight with groove and nose	1500	■	■	
1921	24	straight with groove and "T"	1500	■	■	
1922	24	straight with groove	2200	■	■	☉
1926	18.6	straight	3000	■	■	☉
1927	16	straight with nose	2900	■	■	
1928	16	straight	4000	■	■	☉
1945	16	offset	3200	■	■	☉
1946	14.8	offset	3500	■	■	☉
1947	16	offset with arrow	2800	■	■	
1953	14.6	hollow chamber with wide feet	2200			
1958	36	offset	1500	■	■	
1986	35	offset with flag	1500	■	■	
1987	18	offset	3550	■		☉
1988	18	offset with nose	1900	■		
1989	16	straight with nose	2900	■	■	
1991	18.6	straight	3000	■	■	☉
1993	26	straight with screw channel	1500	■	■	
2006	26	straight	2200	■	■	☉
2007	28	straight	2600	■	■	☉
2014	13.4	offset	3800	■		☉
2016	20	offset with nose	1500	■	■	
2028	14.6	offset	3650	■		☉
2031	20	offset with hook	1600	■	■	
2045	14.6	straight with nose	3000	■	■	
2046	14.6	straight	4500	■	■	☉
2049	22	straight	2600	■	■	☉
2050	25	offset	2200	■		
2051	25	offset with nose	1400	■		
2062	22	straight with nose	2400	■	■	
2063	18	offset with nose	1950	■	■	
2078	20	offset	2600	■	■	☉
2080	30	offset	2000	■	■	
2098	18	offset with nose	1800	■		
2102	14.8	straight	4800	■	■	☉
2103	16	straight	4000	■	■	☉
2104	14	hollow chamber	2200	■	■	
2106	25	straight with noses	2100	■	■	☉
2111	18	straight	3550	■	■	☉
2126	18.6	offset	2800	■	■	☉
2134	14.8	offset with groove	2500	■		
2147	16.6	hollow chamber with wide feet	1800			
2154	18	offset with "T"	1900	■		
2155	25	offset with "T"	1900	■		
2156	13.5	offset	3500	■		☉
2164	12	hollow chamber	3200	■		
2165	24	offset with hook	1300	■	■	
2167	14.8	offset with nose	2100	■	■	
2186	14.8	straight	4800	■	■	☉
2189	16	offset with hook	2100	■		
2191	24	offset with groove	1300	■		
2192	12	straight	5200	■	■	☉
2195	16.5	straight with 2 grooves	3200	■	■	

Article number	Insulating depth (mm)	Description of the geometry	Pieces per stillage *	Foot compatible with aluminum cavity suggestion short hammer	Foot compatible with aluminum cavity suggestion long hammer	Coils **
2196	15	offset	3650	■		☉
2198	28	straight	2600	■	■	☉
2199	24	offset	2500	■		☉
2200	24	offset with hook	1500	■		
2202	22	offset	2500	■		☉
2203	22	offset with nose	1500	■		
2204	22	offset with groove	1500	■		
2206	24	offset	2500	■	■	☉
2214	24	straight with arrow	1300	■	■	
2237	14.8	offset	3650	■	■	☉
2246	32	offset	1600	■		
2250	17	offset	2800	■		☉
2262	17	offset with groove	1800	■		
2263	17	offset with nose	2800	■		
2267	24	straight with nose	1700	■	■	
2268	24	straight with "T"	1700	■	■	
2275	44	offset	1300	■		
2279	24	offset with arrow	1400	■	■	
2285	22	offset	2500	■	■	☉
2305	18.6	straight with nose	2400	■	■	
2310	12	straight	5200	■	■	☉
2311	25	offset with hook	1600	■	■	
2316	24	straight with screw channel	2000	■	■	
2331	24	offset with nose	1550	■	■	
2334	16	straight	4500	■	■	☉
2335	16	straight with arrow	2300	■	■	
2361	32	offset with groove	1300	■		
2365	20	offset with screw channel	2400	■	■	
2366	24	offset with screw channel	2400	■	■	
2375	16	offset with hook	2100	■	■	
2376	16	offset with arrow	2500	■	■	
2379	18	offset	3550	■		☉
2380	22	offset with nose	1300	■	■	
2383	30	straight with screw channel	1400	■	■	
2395	24	offset with nose	1250	■		
2396	24	offset with hook and groove	1500	■		
2423	16	offset	3200	■	■	☉
2424	24	offset	2500	■	■	☉
2425	24	offset with arrow	1250	■	■	
2426	24	offset with groove	1300	■	■	
2427	35	offset	1700	■	■	
2429	39	offset with 3 hollow chambers and 2 flags	450	■		
2432	24	offset with nose	1600	■	■	
2435	34	supplementary profile for sliding systems	430	■	■	
2440	14.8	offset	3650	■	■	☉
2444	18	straight with groove	3000	■		
2455	31.5	profile for hidden sash	850			
2479	20	offset	2600	■	■	☉
2495	20	offset with nose	1800			
2501	28	offset with nose	1000	■	■	
2515	28	offset with nose	800	■	■	
2520	18.6	offset	2900	■	■	☉

\* approximate values, which can deviate in individual cases \*\* Dimensions may differ; LI and RE-LI not available in coils

Article number	Insulating depth (mm)	Description of the geometry	Pieces per stillage *	Foot compatible with aluminum cavity suggestion short hammer	Foot compatible with aluminum cavity suggestion long hammer	Coils **
2521	20	straight	3000	■	■	☉
2522	31.9	straight	2000	■	■	☉
2523	31.9	offset	1500	■	■	
2530	10	offset	5000	■	■	☉
2531	12	offset	4500	■		☉
2535	26	offset	1700	■		
2593	18	offset with hook	1900	■	■	
2594	18	straight with screw channel	2500	■	■	
2605	20	offset	2600	■	■	☉
2614	28	offset with groove	2000	■	■	
2631	32	offset	1600	■		
2632	24	straight with arrow	1300	■	■	
2633	24	straight	3100	■	■	☉
2634	16	straight	4000	■	■	☉
2635	16	straight with arrow	2300	■	■	
2636	41	4 hollow chambers	1000	■	■	
2638	32	straight	2000	■	■	☉
2647	44	offset	1300	■	■	
2649	32	offset with hook and "T"	870	■		
2655	42	offset	1450	■	■	
2656	42	offset with groove	1450	■	■	
2703	18.6	straight with screw channel	2500	■	■	
2705	36.65	spacer for curtain walls	400			
2727	32	offset with hollow chamber	820	■		
2728	32	offset with "T"	1160	■	■	
2729	24	offset with nose	1560	■	■	
2730	24	offset	2760	■	■	
2740	30	offset	1920	■		
2742	20	offset	2600	■		☉
2764	32	straight with screw channel	1300	■	■	
2765	34	offset	1700	■		
2774	24	offset with nose	1570	■	■	
2780	24	offset	2500	■		☉
2793	18.6	straight with nose	1700	■	■	
2794	24	offset	2300	■		☉
2795	28	offset	2000	■	■	
2796	28	offset with hook and "T"	1150	■	■	
2797	18	offset	3550	■	■	☉
2805	34	offset with groove and 2 flags	1140	■		
2807	34	offset with 2 flags	1520	■		
2817	25	offset	2200	■	■	☉
2834	32	supplementary profile for sliding systems	1200			
2835		runner rail for sliding systems	800			
2855	34	offset with 3 hollow chambers	600	■		
2856	34	offset with 2 hollow chambers	750	■		
2857	34	offset with hook and "T"	950	■		
2877	14.6	straight	4500	■	■	☉
2883	27	offset	2300	■		
2884	24	straight	3100	■	■	☉
2899	18	straight with 2 grooves	2300			
2902	24	straight with nose	1300	■	■	
2907	21	straight	2900	■	■	☉

Article number	Insulating depth (mm)	Description of the geometry	Pieces per stillage *	Foot compatible with aluminum cavity suggestion short hammer	Foot compatible with aluminum cavity suggestion long hammer	Coils **
2908	21	straight with nose	1300	■		
2909	21	straight with groove	2500	■		
2910	32	supplementary profile for sliding systems	1200			
2911	32	offset with 2 hooks	1000	■		
2923	32	offset	1600	■		
2951	18	offset with groove	3000			
2952	14.6	straight	4500	■	■	☉
2969	49	offset	1150	■		
3008		supplementary profile for sliding systems	1900			
3010	35	offset	1400	■	■	
3012	34	offset	1500	■	■	
3020	24	offset with flag	1300	■		
3021	24	offset with arrow and groove	1300	■		☉
3022	24	offset with nose	1600	■	■	
3023	24	offset	2500	■	■	☉
3024	24	offset with groove	1320	■	■	☉
3025	32	offset with hook	1400	■		
3057	32	offset with 2 flags	1400	■		
3062	20	offset	2600	■		☉
3068	49	offset with groove	1150	■		
3077		chicane for sliding systems	270			
3078	27	offset	2300	■		
3079	27	straight with nose	1400	■		
3080	27	offset with groove	1300	■		
3102	32	spacer for curtain walls	780			
3109	28	offset with "T"	1400	■	■	
3110	28	offset with 3 hollow chambers	1090	■		
3122	18	offset with nose	1950	■	■	
3123	34	offset	1760	■	■	
3124	34	offset with "T"	1260	■	■	
3125	34	offset with 4 hollow chambers	1060	■		
3129		runner rail holder for sliding systems	860			
3138	14.8	straight	4800	■	■	☉
3145	28	offset with 2 hollow chambers and 2 flags	650	■		
3146	35	offset with 2 grooves and 2 flags	750	■		
3148	24	straight with arrow	1300	■	■	
3149	24	straight with groove	2150	■	■	
3172	34	offset with 2 hollow chambers and 2 flags	540	■		
3199	20	offset with hook	1600	■	■	
3212	31.8	3 hollow chambers with screw channel	1470	■	■	
3229	35	offset	1400	■	■	
3244	28	offset with hollow chamber	300	■		
3255	20	offset with groove	1600	■		
3257	24	offset	2500	■	■	☉
3258	24	offset with arrow	1300	■	■	
3266	19.5	bolt operating profile	3500			☉
3272	42	offset	1400	■		
3273	42	offset with hook and "T"	800	■		
3274	42	offset with 3 hollow chambers	480	■		
3277	54	6 hollow chambers with 2 grooves and noses	600	■		
3278	54	offset with 5 hollow chambers and noses	550	■		
3279	35	offset with 2 flags	700	■		

\* approximate values, which can deviate in individual cases \*\* Dimensions may differ; LI and RE-LI not available in coils

Article number	Insulating depth (mm)	Description of the geometry	Pieces per stillage *	Foot compatible with aluminum cavity suggestion short hammer	Foot compatible with aluminum cavity suggestion long hammer	Coils **
3280	35	offset with groove and 2 flags	1400	■		
3281	35	offset with 2 flags	1000	■		
3282	34	offset with 2 hollow chambers	820	■		
3283	24	offset with double hook	1300	■		
3284	24	straight with noses	2400	■	■	☉
3285	24	offset with arrow	1100	■	■	
3286	14.8	offset with hook	2100	■	■	
3297	15	spacer for curtain walls	1600			
3298		chicane for sliding systems	360			
3307	40	offset with 3 grooves	900	■		
3310	50	offset with groove and flag	700	■		
3311	50	offset	1150	■		
3315	34	offset with groove and 2 flags	840	■		
3316	34	offset with 2 flags	820	■		
3319	47.05	profile for hidden sash	430			
3320		glazing bead	2500			
3338	54	6 hollow chambers with noses and 5 flags	450	■		
3339	54	6 hollow chambers with noses	800	■		
3341	23	offset with hook	1500	■	■	
3342		chicane for sliding systems	360			
3350	35	offset with 2 hollow chambers and 2 flags	500	■		
3351	35	offset with 3 flags	720	■		
3352	35	offset with hook and groove	920	■		
3353	40	straight	2200	■	■	☉
3354	40	offset	1500	■	■	
3368	14.8	straight with nose	3000	■	■	
3369	18.6	straight	3000	■	■	☉
3370	18.6	straight with nose	2200	■	■	
3371	24	straight	3100	■	■	☉
3372	24	straight with nose	1300	■	■	
3373	18	offset with nose	1900	■	■	
3374	18	offset with groove	1700	■		
3375	18	offset	3550	■	■	☉
3377	34	offset with groove	1100	■		
3378	14.6	hollow chamber with wide feet and nose	1300			
3379	34	offset with 2 "T"	900	■	■	
3380	24	straight with noses	2400	■	■	
3386	24	2 hollow chambers	2000	■	■	
3387	24	offset with "T"	1800	■		
3388	14.8	offset	3650	■	■	☉
3389	18.6	offset	2800	■	■	☉
3390	24	offset	2500	■	■	☉
3391	35	offset	1700	■		
3392	35	offset with hook, groove and 3 flags	500	■		
3398	39	offset with 3 hollow chambers and 2 flags	440	■		
3399	39	offset with 2 flags	950	■		
3400	39	offset with groove and 2 flags	750	■		
3413	28	offset with hollow chamber	1150	■	■	
3419	30	offset with hook	1600	■	■	
3424		supplementary profile for sliding systems	2500			
3425	24	offset with arrow	1250	■		
3432	30	straight	2500	■	■	

Article number	Insulating depth (mm)	Description of the geometry	Pieces per stillage *	Foot compatible with aluminum cavity suggestion short hammer	Foot compatible with aluminum cavity suggestion long hammer	Coils **
3433	26	straight with screw channel	1700	■	■	
3444	32	offset with nose	840	■		
3448	24	offset	2650	■	■	☉
3454	20	offset with nose	1500	■		
3493		chicane for sliding systems	900			
3494		chicane for sliding systems	320			
3546	20	2 hollow chambers	2200	■		
3555	29	offset	1950	■		
3557	14	offset	3500	■	■	☉
3560	12	straight	5200	■	■	☉
3582	19.5	bolt operating profile	4000			☉
3584	26.25	spacer for curtain walls	840			
3585	21.15	spacer for curtain walls	1000			
3591	20	straight	2900	■	■	☉
3606	30	2 hollow chambers with flag	1300	■		
3620	34	offset with 2 "T" and 2 flags	750	■	■	
3621	18	offset with nose	2000	■	■	
3622	24	offset with hook	1800	■		
3623	34	offset with 2 "T"	1200	■	■	
3632	10	straight	6000	■	■	☉
3633	14.8	offset	3500	■		☉
3636	39	offset with groove and 2 flags	800	■		
3637	39	offset with 2 flags	650	■		
3638	39	offset with groove and 2 flags	550	■		
3639	39	offset with 3 hollow chambers and 2 flags	400	■		
3640	39	offset with 3 hollow chambers and 2 flags	440	■		
3641	46	offset	1200	■		
3655	34	offset with flag	800	■		
3660	34	offset with flag	1050	■		
3668	19.5	bolt operating profile	4200			☉
3693	11.6	spacer for curtain walls	2500			
3714	16	offset	4000	■	■	☉
3715	18	offset	3500	■	■	☉
3716	22	offset	2900	■	■	☉
3723	31.9	offset	1900	■		
3724	28	offset	2000	■	■	
3725	14	hollow chamber	4000	■	■	
3726	32	supplementary profile for sliding systems	1300			
3745	14.8	offset with "T"	2300	■	■	
3746	34	offset with groove	1950	■	■	
3747	17.6	spacer for curtain walls	1800			
3760	31.8	3 hollow chambers with screw channel	1400	■	■	
3761	29	offset	2100	■		
3778	17.7	bolt operating profile	2900			☉
3784	18.6	offset with hook	1000	■	■	
3790	30	offset with flag	800	■	■	
3798	28	offset with flag	1100	■	■	
3804	21	offset	2800	■	■	☉
3812	40	offset	1440	■	■	
3813	36	offset	1600	■	■	
3824	38	offset	1600	■	■	
3825	34	3 hollow chambers with groove	940	■	■	









\* approximate values, which can deviate in individual cases \*\* Dimensions may differ; LI and RE-LI not available in coils



Article number	Insulating depth (mm)	Description of the geometry	Pieces per sillage *	Foot compatible with aluminum cavity suggestion short hammer	Foot compatible with aluminum cavity suggestion long hammer	Coils **
3826	34	offset with 2 hollow chambers	840	■	■	
3827	39	offset	1600	■	■	
3828	39	2 hollow chambers with groove	900	■	■	
3829	34	offset	1800	■	■	
3836	17.5	spacer for curtain walls	1150			
3842	28	offset with groove and flag	1100	■	■	
3843	28	offset with hollow chamber and flag	720	■	■	
3848	34	3 hollow chambers	1300	■	■	
3864	39	offset with 2 flags	950	■		
3884	30	shear-free profile	1700	■	■	
3889	32	offset with flag	1050	■	■	
3893	24	offset with hollow chamber	1050	■	■	
3896	28	offset with flag	1200	■	■	
3909	17	hollow chamber with wide feet	1800			
3918	22	offset with nose	1500	■	■	
3920	28	offset with flag	1200	■	■	
3935	34	offset	1800	■	■	
3936	35	2 hollow chambers	850	■	■	
3957	32	offset with flag	1200	■		
3963	20	shear-free profile	2400	■	■	
3966	43.5	profile for hidden sash	600			
3984	39	offset with groove	1000	■	■	
3985	15	offset with nose	2500	■		
3986	34	3 hollow chambers	1200	■	■	
3989	18	shear-free profile	2500	■	■	
3995	22	shear-free profile	2300	■	■	
3998	24	shear-free profile	2100	■	■	
4004	26	shear-free profile	1950	■	■	
4007	28	shear-free profile	1800	■	■	
4010	32	shear-free profile	1600	■	■	
4013	34	shear-free profile	1450	■	■	
4019	42	shear-free profile	1200	■	■	
4022	42	offset with 3 hollow chambers	550	■		
4056	28	offset with flag	1500	■		
4059	14.6	hollow chamber with wide feet	2500			
4060	14.6	straight with screw channel	3000	■	■	
4061	16	hollow chamber with wide feet	1800			
4062	50	offset	1150	■		
4063	24	offset with hook	1600	■	■	
4075	38	offset	1600	■	■	
4101	24	offset with hook	1600	■	■	
4102	16	offset with arrow	2500	■	■	
4178	29	offset	2000	■		
4192	39	offset	1600	■	■	
4199	20	2 hollow chambers	2200	■		
4200	28	offset	2000	■	■	
4202	42	offset	1450	■	■	
4214	24.8	offset	2200	■	■	
4215	24.8	offset with nose	1600	■	■	
4216	24.8	offset with hook	1900	■	■	
4245	20	straight	2900	■	■	
4262	30	offset	2000	■	■	

Article number	Insulating depth (mm)	Description of the geometry	Pieces per stillage *	Foot compatible with aluminum cavity suggestion short hammer	Foot compatible with aluminum cavity suggestion long hammer	Coils **
4263	22	offset	2500	■		☉
4271	25.3	offset	2200	■		
4272	25.3	offset with hollow chamber	1200	■		
4275	34	straight with screw channel	1400	■	■	
4276	38	offset	1600	■	■	
4277	38	straight	2200	■	■	☉
4283	24	offset with hollow chamber	1050	■	■	
4296	28	offset with 2 flags	1500	■	■	
4298	28	offset with "T" and flag	1400	■	■	
4317	25.3	offset with groove	1300	■		
4318	35.3	3 hollow chambers with hook and "T"	940	■		
4319	35.3	offset with 3 hollow chambers	850	■		
4320	35.3	3 hollow chambers	1500	■		
4325	37	offset	1600	■	■	
4327	34	offset with groove and 2 flags	1140	■		
4329	20.5	spacer for curtain walls	1350			
4330	25	hollow chamber with wide feet and groove	1400			
4331	29.7	supplementary profile for curtain walls	2500			
4332	37.7	supplementary profile for curtain walls	1900			
4347	34	offset with groove	1200	■		
4348	44	offset with 2 grooves	740	■		
4349	44	offset with 4 hollow chambers	550	■		
4351	20	offset with groove	1600	■		
4362	36	shear-free profile	1300	■	■	
4365	37	offset	1600	■		
4367	☹	30	offset with flag	1050	■	■
4368	☹	30	offset with groove	1300	■	■
4370	☹	30	offset	2000	■	■
4371	☹	30	offset with groove and flag	1150	■	■
4386	14	offset	3600	■	■	☉
4388	24	offset with nose	1600	■	■	
4396	35	offset with 2 flags	1000	■		
4402	34	offset with 2 "T"	900	■	■	
4430	36.5	profile for hidden sash	700			
4458	☹	43	offset	1400	■	
4461	52	straight	1700	■	■	
4467	32	offset with 2 flags	1400	■	■	
4468	32	offset with groove and 2 flags	1100	■	■	
4469	32	offset with hollow chamber and 2 flags	1000	■	■	
4474	☹	33	offset	1700	■	
4492	26	straight	2800	■	■	☉
4493	26	offset	2500	■		
4494	26	offset with nose	1450	■		
4503	☹	42	offset with 2 flags	850	■	
4518	40	straight	2200	■	■	
4542	26	offset	2500	■	■	
4543	24	offset	2500	■	■	☉
4544	24	offset with hook	1600	■	■	
4557	24	offset with hook	1600	■		
4558	40	profile for hidden sash	850			
4607	46	shear-free profile	1100	■	■	
4616	26	straight	2800	■	■	

\* approximate values, which can deviate in individual cases \*\* Dimensions may differ; LI and RE-LI not available in coils

Article number	Insulating depth (mm)	Description of the geometry	Pieces per stillage *	Foot compatible with aluminum cavity suggestion short hammer	Foot compatible with aluminum cavity suggestion long hammer	Coils **
4617	26	straight with screw channel	1700	■	■	
4618	28	offset	2000	■	■	
4619	30	straight	2500	■	■	
4620	32	offset	1600	■	■	
4621	34	offset	1800	■	■	
4622	44	offset	1300	■	■	
4623	39	offset with 3 hollow chambers	600	■	■	
4666 	48	offset	1150	■	■	
4680	45	4 hollow chambers	1100	■	■	
4682	45	4 hollow chambers with 3 hooks and "T"	660	■	■	
4683	18	hollow chamber with wide feet and groove	1800			
4698	12	straight with nose	3500	■	■	
4700		pressure plate	500			
4701	39	offset with 2 flags	680	■	■	
4720	34	offset with 4 hollow chambers and 2 flags	650	■		
4777 	18	offset with hollow chamber	1950	■		
4786 	39	offset with groove and 2 flags	950	■	■	
4788 	32	shear-free profile with groove	1000			
4789 	44	shear free profile	1150	■	■	
4804 	28	offset with 2 flags	1200	■	■	
4807 	45	offset with 2 flags	950	■		
4813 	77	offset	650	■		

## Additional information

Accompanying product brochures, recommendations and datasheets are available on request or from the download area on our website at any time [insulbar.com](http://insulbar.com).

### Product brochures

- insulbar with Low-E film
- Shear-free insulating profile from insulbar
- insulbar ESP
- insulbar RE
- insulbar LI
- insulbar RE-LI

### Recommendations

- Transport, storage, delivery form
- Coating of insulbar from polyamide GF
- Anodizing of insulbar from polyamide GF
- Processing of shear-free profiles

### Datasheets

- insulbar REG made from TECATHERM 66 GF or 66 GF40
- insulbar RE made from TECATHERM 66 GF RE
- insulbar LI made from TECATHERM 66 GF
- insulbar RE-LI made from TECATHERM 66 GF RE
- insulbar ESP made from TECATHERM 66 ESP
- Coex wire
- Low-E film 12 ε 3
- Cover film 8.4 T 200
- Cover film 5.5 T 200
- Surface protection film



*We will be pleased to send you additional information such as test reports, certificates etc. on request.*

***insulbar Germany***

Ensinger GmbH  
Rudolf-Diesel-Straße 8  
71154 Nufringen  
Tel. +49 7032 819 0  
Fax +49 7032 819 270  
insulbar@ensingerplastics.com

Ensinger GmbH  
Wilfried-Ensinger-Straße 1  
93413 Cham  
Tel. +49 9971 396 0  
Fax +49 9971 396 570  
insulbar@ensingerplastics.com

***insulbar worldwide***

***France***  
Ensinger France S.A.R.L.  
Rue des Petites Combes  
ZAC des Batterses  
01700 Beynost  
Tel. +33 4 78 55 36 35  
Fax +33 4 78 55 68 41  
contact@ensinger.fr

***Italy***  
Ensinger Italia S.R.L.  
Via Franco Tosi 1/3  
20020 Olcella di Busto Garolfo  
Tel. +39 0331 562 111  
Fax +39 0331 567 822  
insulbar.it@ensingerplastics.com

***Spain***  
Ensinger S.A.  
Girona, 21-27  
08120 La Llagosta  
Tel. +34 935 74 57 26  
Fax +34 935 74 27 30  
insulbar@ensinger.es

***United Kingdom***  
Ensinger Building Products Ltd.  
Wilfried Way  
Tonyrefail  
Mid Glamorgan  
CF39 8JQ  
Tel. +44 1443 678 400  
Fax +44 1443 671 153  
ebp-uk@ensingerplastics.com

***China***  
Ensinger (China) Co., Ltd.  
1F, Building A3  
No. 1528 Gumei Road  
Shanghai 200233  
Tel. +86 21 522 851 11  
Fax +86 21 522 852 22  
info@ensinger-china.com

***USA***  
Ensinger Inc.  
1 Main St.  
Grenloch, NJ 08032  
Tel. +1 856 227 0500  
Fax +1 856 232 1754  
insulbar@ensingerusa.com

*Ensinger®, TECA®, insulbar® and TECATHERM® are registered trademarks of Ensinger GmbH.*

*insulbar.com*